

DWC-MB44WiAC1T, DWC-MB44Wi605C1T: 1TB local memory for recording  
 DWC-MB44WiAC5, DWC-MB44Wi605C5: 512GB local memory for recording



Default Login Information	
Username: <b>admin</b>	Password: <b>admin</b>

**WHAT'S IN THE BOX**

Item	Quantity	Description	Image	Quantity
Quick Setup Guide	1	Screws and Plastic Anchors - 4pcs		1 Set
Mounting Template	1	Star Wrench (T-20)		1
Test Video Cable	1	DC Plug Cable		1
Waterproof Cap and Rubber Rings (Black: ø0.15" (ø4mm), White: ø0.19" (ø5mm))	1 Set			

**NOTE:** Download all your support materials and tools in one place.

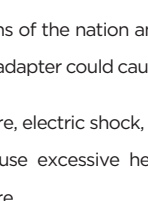
- Go to: <http://www.digital-watchdog.com/resources>
- Search your product by entering the part number in the 'Search by Product' search bar. Results for applicable part numbers will populate automatically based on the part number you enter.
- Click 'Search!'. All supported materials, including manuals and quick start guide (QSGs) will appear in the results.

**Attention:** This document is intended to serve as a quick reference for the initial setup. It is recommended that the user read the entire instruction manual for complete and proper installation and usage.

**SAFETY AND WARNING INFORMATION**

Read through this Installation Guide carefully before installing the product. Keep the Installation Guide for future reference. See the user manual for more information on the proper installation, use and care of the product. These instructions are intended to ensure that users can use the product correctly to avoid danger or property loss. Warnings: Serious injury or death may occur if any of the warnings are neglected.

**CAUTIONS:** Injury or equipment damage may occur if any of the cautions are neglected.

**WARNING**

- In the use of the product, you must be strict compliance with the electrical safety regulations of the nation and region. When the product is mounted on a wall or ceiling, the device shall be firmly fixed.
- Be sure to use only the standard adapter specified in the specification sheet. Using any other adapter could cause fire, electrical shock, or damage to the product.
- Make sure the power supply voltage is correct before using the camera.
- Incorrectly connecting the power supply or replacing the battery may cause an explosion, fire, electric shock, or damage to the product.
- Do not connect multiple cameras to a single adapter. Exceeding the capacity may cause excessive heat generation or fire.
- Securely plug the power cord into the power source. An insecure connection may cause a fire.
- When installing the camera, fasten it securely and firmly. A falling camera may cause personal injury.
- Do not install in a location subject to elevated temperature, low temperature, or high humidity. Doing so may cause fire or electric shock.
- Do not place conductive objects (e.g. screwdrivers, coins, metal items, etc.) or containers filled with water on top of the camera. Doing so may cause personal injury due to fire, electric shock, or falling objects.
- Do not install in humid, dusty, or sooty locations. Doing so may cause fire or electric shock.
- Do not install near any heat sources such as radiators, heat registers, or other products (including amplifiers) that produce heat.
- Keep away from direct sunlight and heat radiation sources. It may cause a fire.
- If any unusual smells or smoke come from the unit, stop using the product at once. Immediately disconnect the power source and contact the service center. Continued use in such a condition may cause fire or electric shock.
- If this product does not operate normally, contact the nearest service center. Never disassemble or change this product in any way.
- When cleaning the product, do not spray water directly onto parts of the product. Doing so may cause fire or electric shock.

**CAUTION**

- Use proper safety gear when installing and wiring the product.
- Do not drop objects on the product or apply strong shock to it. Keep away from a location subject to excessive vibration or magnetic interference.
- Do not use this product near water.
- The product shall not be exposed to dripping or splashing and no objects filled with liquids, such as vases, shall be placed on the product.
- Avoid aiming the camera directly towards extremely bright objects such as the sun, as this may damage the image sensor.
- The Main plug is used as a disconnect device and shall stay readily operable at any time.
- Remove the power adapter from the outlet when there is lightning. Neglecting to do so may cause fire or damage to the product.
- Do not block any ventilation openings. Install following the manufacturer's instructions.
- A polarized or grounding-type plug is recommended for this product. A polarized plug has two blades with one wider than the other. A grounding-type plug has two blades and a third grounding prong. If the provided plug does not fit into your outlet, consult an electrician for replacement.
- Protect the power cord from being walked on or pinched particularly at plugs, convenience receptacles, and the point where they exit from the product.
- If any laser equipment is used near the product, make sure the surface of the sensor is not exposed to the laser beam as that may damage the sensor module.
- If you want to move the already installed product, be sure to turn off the power and then move or reinstall it.
- Proper configuration of all passwords and other security settings is the responsibility of the installer and/or end-user.
- If cleaning is necessary, please use a clean cloth to wipe it gently. If the device will not be used for a long time, please cover the lens cap to protect the device from dirt.
- Do not touch the camera's lens or sensor module with fingers. If cleaning is necessary, please use a clean cloth to wipe it gently. If the device will not be used for a long time, please cover the lens cap to protect the device from dirt.
- Use only attachments/accessories specified by the manufacturer.
- Always use hardware (e.g. screws, anchors, bolts, locking nuts, etc.) compatible with the mounting surface and of sufficient length and construction to ensure a secure mount.
- Use only with cart, stand, tripod, bracket, or table specified by the manufacturer, or sold with the product.
- Unplug this product when a cart is used. Use caution when moving the cart/product combination to avoid injury from tip-over.
- Refer all servicing to qualified service personnel. Servicing is needed when the product has been damaged in any way, such as power supply cord or plug is damaged, liquid has been spilled or objects have fallen into the product, the product has been exposed to rain or moisture, does not operate normally, or has been dropped.

**STEP 1 - PREPARING TO MOUNT THE CAMERA**

- The mounting surface must withstand five times the camera weight.
- Do not let the cables get caught in improper places or the electric line cover can be damaged. This may cause a short or fire.
- CAUTION:** These servicing instructions are for use by qualified service personnel only. To reduce the risk of electric shock do not perform any servicing other than that contained in the operating instructions unless you are qualified to do so.
- This product is intended to be supplied by a UL Listed Power Supply Unit marked "Class 2" or "LPS" or "PS2" and rated 12 Vdc, 470 mA min.
- The wired LAN hub providing power over the Ethernet (PoE) in accordance with IEEE 802.3af shall be a UL Listed device with the output evaluated as a Limited Power Source as defined in UL60950-1 or PS2 as defined in UL62368-1.
- Unit is intended for installation in a Network Environment 0 as defined in IEC TR 62102. As such, associated Ethernet wiring shall be limited to inside the building.
- Using the mounting template sheet or the camera itself, mark and drill the necessary holes in the wall or ceiling.

**STEP 2 - CABLING THE CAMERA TO EXTERNAL DEVICES**

Pass the wires through the mount bracket and make all necessary connections.

- When using a PoE Switch, connect the camera using an Ethernet cable for both data and power.
- When using a non-PoE switch, connect the camera to the switch using an Ethernet cable for data transmission and use a power adapter to power the camera.

Power requirements	Power consumption
DC12V, PoE (IEEE 802.3af class 3). Adapter not Included.	DC12V: max 11W PoE: max 12.9W

**STEP 3 - INSTALLING THE CAMERA**

- Once all cables are connected, secure the camera to the mounting surface using the included screws.
- The waterproof cap set comes with two rubber rings. Use the rubber ring best suited for your network cable's diameter.
  - Pass the LAN cable through the waterproof cap, gasket and the **a** rubber ring.
  - Connect the LAN cable to the camera's network port **b**.
  - c** will affix to **b** with a ¼ turn counter-clockwise.
  - Thread and twist **d** tightly to **c**.

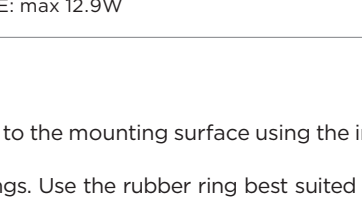
**NOTE:** To ensure moisture seal, make sure the o-ring is in place between **a** and **b**. In extreme environments use of an outdoor rated sealer is recommended.

**NOTE:** Cables with ø4.5mm to ø5.5mm thickness should use the black rubber ring. Cables over ø5.5mm in thickness should use the white rubber ring.

- Loosen the pan and tilt screws at the base of the camera's bracket to adjust the camera's view and position.

Resetting the camera: To reset the camera, use the tip of a paper clip or a pencil and press the reset button. Pressing the button for five (5) seconds will initiate a camera-wide reset of all the settings, including network settings.

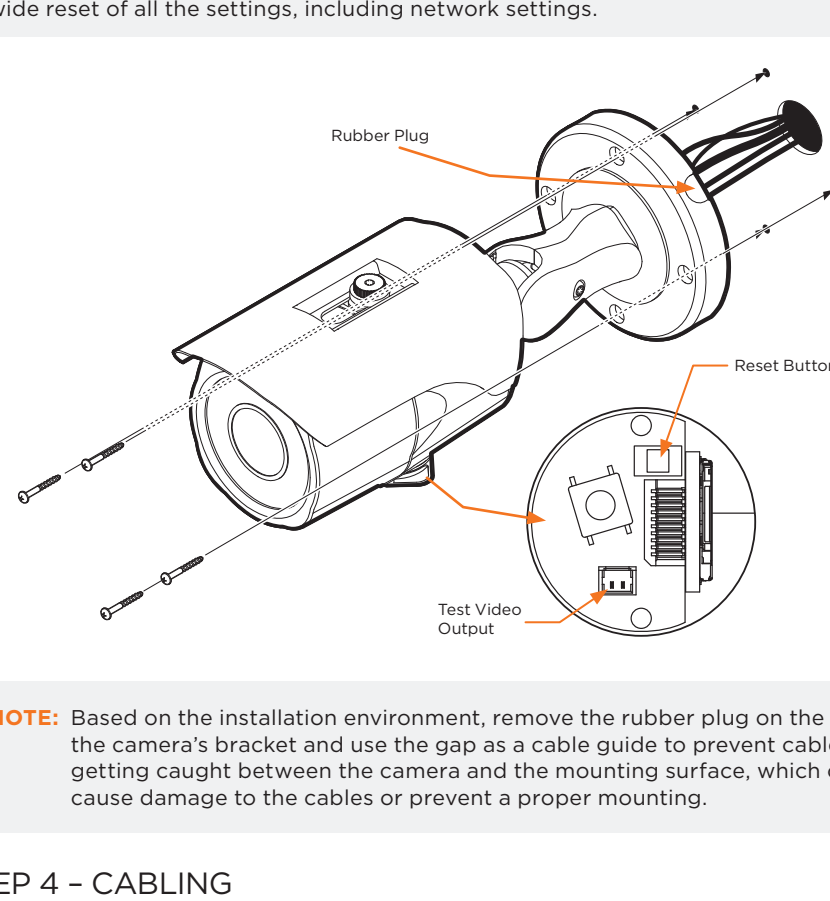

**NOTE:** Based on the installation environment, remove the rubber plug on the side of the camera's bracket and use the gap as a cable guide to prevent cables from getting caught between the camera and the mounting surface, which can cause damage to the cables or prevent a proper mounting.

**STEP 4 - CABLING**

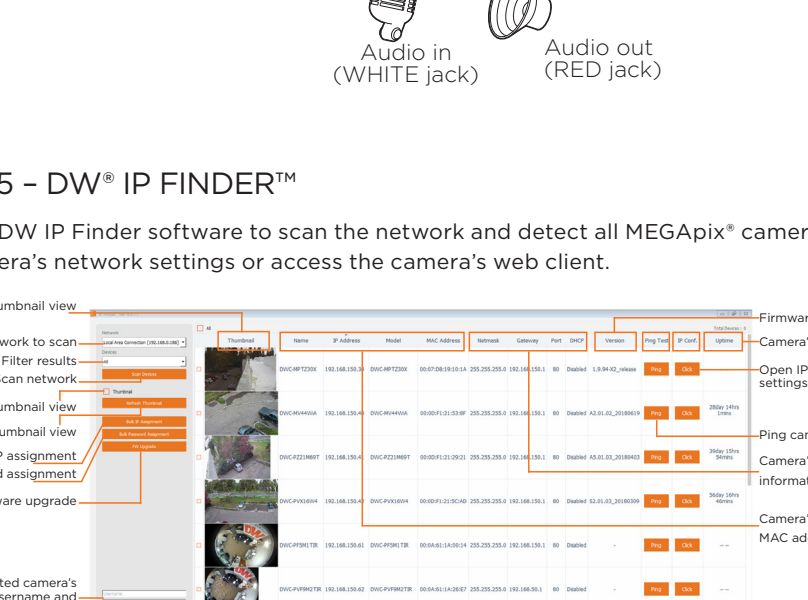
Use the diagram below to properly connect power, network, audio, alarm and sensors to the camera.

**STEP 5 - DW® IP FINDER™**

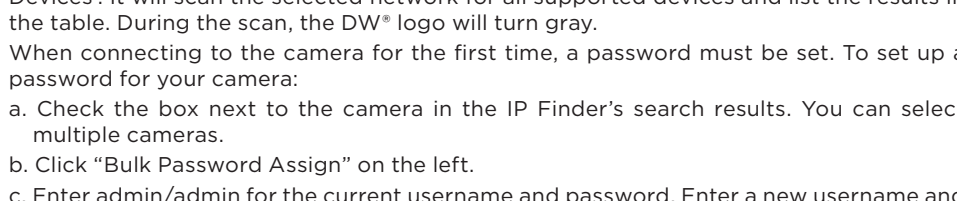
Use the DW IP Finder software to scan the network and detect all MEGAPIX® cameras, set the camera's network settings or access the camera's web client.



- To install the DW IP Finder, go to: <http://www.digital-watchdog.com>
- Enter "DW IP Finder" on the search box at the top of the page.
- Go to the "Software" tab on the DW IP Finder page to download the installation file.
- Follow the installation to install the DW IP Finder. Open the DW IP Finder and click 'Scan Devices'. It will scan the selected network for all supported devices and list the results in the table. During the scan, the DW® logo will turn gray.
- When connecting to the camera for the first time, a password must be set. To set up a password for your camera:
  - Check the box next to the camera in the IP Finder's search results. You can select multiple cameras.
  - Click "Bulk Password Assign" on the left.
  - Enter admin/admin for the current username and password. Enter a new username and password to the right.

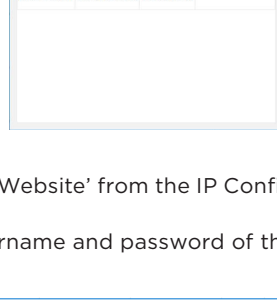

- Select a camera from the list by double-clicking on the camera's image or clicking on the 'Click' button under the IP Conf. column. The pop-up window will show the camera's current network settings, allowing admin users to adjust the settings as needed.
- To access the camera's web page, click on the 'View Camera Website' from the IP Config window.
- To save changes made to the camera's setting, enter the username and password of the camera's admin account and click 'Apply'.

Select DHCP to allow the camera to receive its IP address automatically from the DHCP server.

Select "Static" to manually enter the camera's IP address, (Sub)Netmask, Gateway and DNS information.

The camera's IP must be set to static if connecting to Spectrum® IPVMS. Contact your network administrator for more information.

Default TCP/IP information: DHCP.

Port forwarding must be set in your network's router to access the camera from an external network.

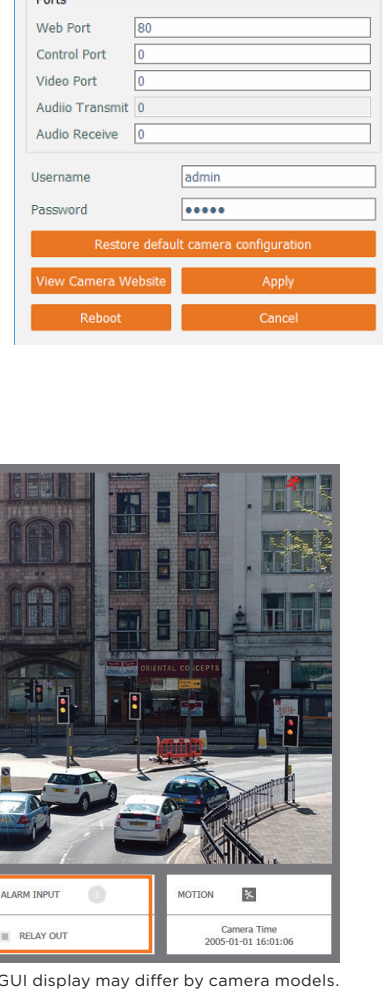
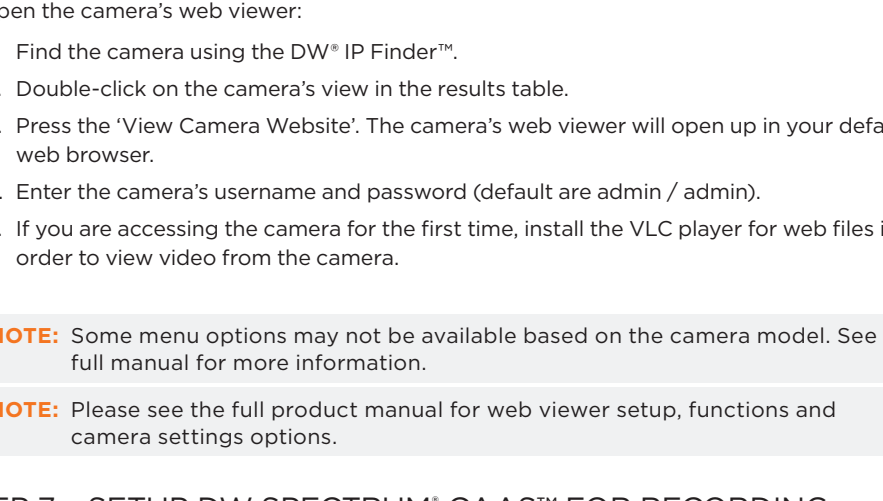
**STEP 6 - WEB VIEWER**

The GUI display may differ by camera models.

Once the camera's network settings have been setup properly, you can access the camera's web viewer using the DW® IP Finder™.

To open the camera's web viewer:

- Find the camera using the DW® IP Finder™.
- Double-click on the camera's view in the results table.
- Press the 'View Camera Website'. The camera's web viewer will open up in your default web browser.
- Enter the camera's username and password (default are admin / admin).
- If you are accessing the camera for the first time, install the VLC player for web files in order to view video from the camera.

**\*NOTE:** Some menu options may not be available based on the camera model. See the full manual for more information.

**NOTE:** Please see the full product manual for web viewer setup, functions and camera settings options.

**STEP 7 - SETUP DW SPECTRUM® CAAS™ FOR RECORDING**

To complete the DW Spectrum® CaaS™ server's setup and start recording, see the DW Spectrum® CaaS™ QSG for additional information.